

Mera-Tech GmbH

Wibachstrasse 8 CH-8153 Rümlang

Telefon: +41 44 817 20 12

Telefax: +41 44 817 20 11

Mobil: +41 79 104 12 20

Mail: r.saliji@mera-tech.ch

**INHALTSVERZEICHNIS**

Verkaufs- und Lieferbedingungen 0.002

KANÄLE + FORMSTÜCKE

Preisfaktoren und allgemeine Zuschläge 1.001

Verkaufs- und Lieferbedingungen 1.002

Gerade Kanäle 1.010

Verstärkungsrahmen für Kanäle 1.020

Stutzen 1.030

Schiebestutzen 1.040

Konen 1.050

S-Etagen 1.060

Bogen 1.070

Eckbogen 1.080

Uebergang 1.090

T-Stücke 1.100

Boden 1.110

Maschengitter 1.120

Flexmanschette 1.130

KOMPONENTEN

Einstellklappen 2.010

Motorklappen ALU 2.020

Wetterschutzgitter ALU 2.030

Regenhüte rund 2.040

Regenhüte eckig 2.050

Schalldämpfer-Kulissen 100 mm 2.061

Schalldämpfer-Kulissen 100 mm Spezifikationen 2.062

Schalldämpfer-Kulissen 150 mm 2.063

Schalldämpfer-Kulissen 150 mm Spezifikationen 2.064

Schalldämpfer-Kulissen 200 mm 2.065

Schalldämpfer-Kulissen 200 mm Spezifikationen 2.070

RUNDPROGRAMM

Verbindungen, Rohre 3.010

Rohrbogen 3.020

Segmentbogen 3.030

Reduktionen 3.040

T- und Sattelstücke, Hosenrohre 3.050

Maschengitter Stutzen Deckel 3.060

Rondellen und Einstellklappen 3.070

Schlauchbriden 3.080

Rohrbriden 3.090

Mera-Tech GmbH

Wibachstrasse 8 CH-8153 Rümlang

Telefon: +41 44 817 20 12

Telefax: +41 44 817 20 11

Mobil: +41 79 104 12 20

Mail: r.saliji@mera-tech.ch



Mera-Tech GmbH
Wibachstrasse 8 CH-8153 Rümlang

Telefon: +41 44 817 20 12
Telefax: +41 44 817 20 11
Mobil: +41 79 104 12 20

Mail: r.saliji@mera-tech.ch



Verkaufs- und Lieferbedingungen

Mera-Tech GmbH
Wibachstrasse 8 CH-8153 Rümlang

Telefon: +41 44 817 20 12
Telefax: +41 44 817 20 11
Mobil: +41 79 104 12 20

Mail: r.saliji@mera-tech.ch



1 KANÄLE + FORMSTÜCKE

Preisfaktoren und allgemeine Zuschläge	1.001
Verkaufs- und Lieferbedingungen	1.002
Gerade Kanäle	1.010
Verstärkungsrahmen für Kanäle	1.020
Stutzen	1.030
Schiebestutzen	1.040
Konen	1.050
S-Etagen	1.060
Bogen	1.070
Eckbogen	1.080
Uebergang	1.090
T-Stücke	1.100
Boden	1.110
Maschengitter	1.120
Flexmanschette	1.130

Mera-Tech GmbH
Wibachstrasse 8 CH-8153 Rümlang

Telefon: +41 44 817 20 12
Telefax: +41 44 817 20 11
Mobil: +41 79 104 12 20

Mail: r.saliji@mera-tech.ch



Preisfaktoren und allgemeine Zuschläge

Preisfaktoren und allgemeine Zuschläge

Kanalverbindungen / Dichten / Verstärkungen

Kanalverbindungen:	MM-Rahmen (20mm)	Preisliste x Faktor 1.20
	HM-Rahmen (30 mm)	Preisliste x Faktor 1.35
Lose gelieferte Profile:	MM-Rahmen	pro lfm. Fr. 4.—
	HM-Rahmen	pro lfm. Fr. 7.—
	MM-Ecken	pro Stück Fr. 0.80
	HM;-Ecken	pro Stück Fr. 1.40
Verstärkte Ausführung		Preisliste x Faktor 1.10
Dichten		Preisliste x Faktor 1.10
Verstärken und Dichten		Preisliste x Faktor 1.20
Höhere Blechstärke gegenüber Den Normblechstärken		Preisliste x Faktor 1.10

Zusammenbau / Ausschnitte / Einbauten usw.

Kanalzusammenbau	bis 1.00 m2 Fr. 15.— / Stück Ab 1.01 m2 Fr. 25.— / Stück
Kanalausschnitte / Stutzenaufbauten / Schrägschnitte an Kanalende	Bis 1.00 m2 Fr. 7.— / Stück Ab 1.01 m2 Fr. 10.— / Stück
Einbau von:	
- Wetterschutzgitter	
- Maschengitter	- Schalldämpferkulissee
- Einstellklappen	- Motorklappen
	bis 1.00 m2 Fr. 15.— / Stück Ab 1.01 m2 Fr. 25.— / Stück

Gerade Kanäle

Bauteil-Nr. 1

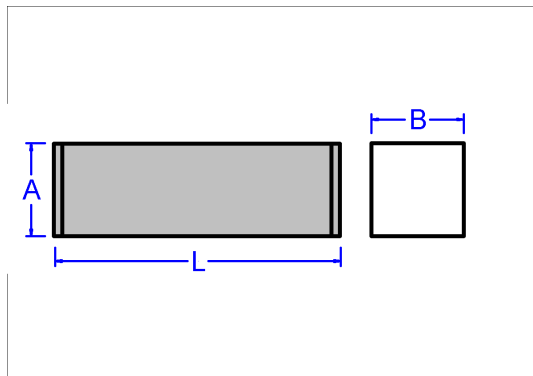

		B														
		200	300	400	500	600	700	800	900	1000	1100	1200	1400	1600	1800	2000
A																
200		31	36	40	42	51	56	73	76	92	97	106	134	151	163	176
300		36	40	42	45	56	62	76	79	96	105	116	149	165	180	186
400		40	42	45	49	62	66	79	85	105	118	124	156	176	186	197
500		42	45	49	55	66	69	85	92	116	122	125	166	186	192	202
600		51	56	62	66	69	73	92	102	122	125	132	177	194	200	210
700		56	62	66	69	73	80	102	106	127	132	145	186	201	207	220
800		73	76	79	85	92	102	106	111	132	145	153	194	212	219	227
900		76	79	85	92	102	106	111	115	145	153	163	200	221	226	237
1000		92	96	105	116	122	127	132	145	153	163	169	210	232	236	245
1100		97	105	118	122	125	132	145	153	163	169	174	221	241	245	255
1200		106	116	124	125	132	145	153	163	169	174	185	232	247	252	263
1400		141	149	156	166	177	186	194	200	210	221	232	251	268	285	302
1600		151	165	176	186	194	201	212	221	232	241	247	268	285	293	316
1800		163	180	186	192	200	207	219	226	236	245	252	285	293	307	327
2000		176	186	197	202	210	220	227	237	245	255	263	302	316	327	342

Verstärkungsrahmen für Kanäle

Bauteil-Nr. 2

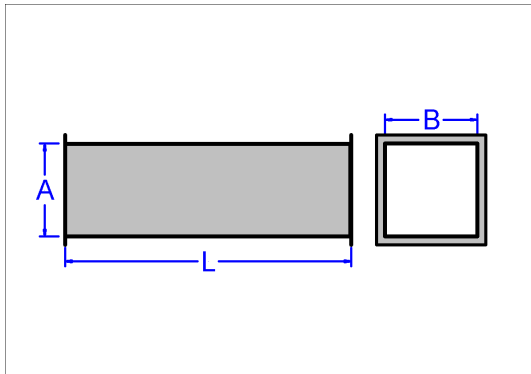

		B														
		200	300	400	500	600	700	800	900	1000	1100	1200	1400	1600	1800	2000
A																
200		17	19	20	21	25	26	31	36	41	46	55	79	86	95	102
300		19	20	21	25	26	31	36	41	46	55	67	86	95	102	107
400		20	21	25	26	31	36	41	46	55	67	79	95	102	107	112
500		21	25	26	31	36	41	46	55	67	79	86	102	107	112	116
600		25	26	31	36	41	46	55	67	79	86	95	107	112	116	120
700		26	31	36	41	46	55	67	79	86	95	102	112	116	120	122
800		31	36	41	46	55	67	79	86	95	102	107	116	120	122	125
900		36	41	46	55	67	79	86	95	102	107	112	120	122	125	129
1000		41	46	55	67	79	86	95	102	107	112	116	122	125	129	132
1100		46	55	67	79	86	95	102	107	112	116	120	125	129	132	136
1200		55	67	79	86	95	102	107	112	116	120	122	129	132	136	139
1400		79	86	95	102	107	112	116	120	122	125	129	136	139	140	142
1600		86	95	102	107	112	116	120	122	125	129	132	139	140	142	147
1800		95	102	107	112	116	120	122	125	129	132	136	140	142	147	151
2000		102	107	112	116	120	122	125	129	132	136	139	142	147	151	157

Stutzen

Bauteil-Nr. 4

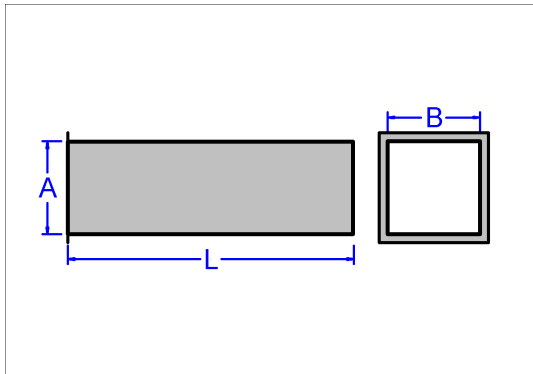

		B														
		200	300	400	500	600	700	800	900	1000	1100	1200	1400	1600	1800	2000
A																
200		19	21	24	26	29	31	34	35	38	42	44	51	56	61	67
300		21	24	25	28	31	32	35	36	44	45	46	52	59	62	69
400		24	25	26	31	32	34	36	38	45	49	51	55	61	64	70
500		26	28	31	32	34	35	38	40	49	51	54	56	62	67	73
600		29	31	32	34	35	38	40	44	51	55	56	60	64	69	77
700		31	32	34	35	38	41	46	50	54	59	60	64	67	71	80
800		34	35	36	38	40	46	50	52	56	61	62	66	70	73	85
900		35	36	38	40	44	50	52	55	60	62	64	69	71	75	87
1000		42	45	49	51	55	59	61	62	64	66	69	73	79	84	95
1100		42	45	49	51	55	59	61	62	64	66	69	73	79	84	95
1200		44	46	51	54	56	60	62	64	66	69	71	79	85	90	97
1400		51	52	55	56	60	64	66	69	70	73	75	80	87	94	99
1600		56	59	61	62	64	67	70	71	75	79	81	86	94	99	105
1800		61	62	64	67	69	71	73	75	79	84	90	94	99	104	107
2000		67	69	70	73	77	80	85	87	92	94	95	99	105	107	112

Mera-Tech GmbH
Wibachstrasse 8 CH-8153 Rümlang

Telefon: +41 44 817 20 12
Telefax: +41 44 817 20 11
Mobil: +41 79 104 12 20

Mail: r.saliji@mera-tech.ch



Schiebestutzen

Bauteil-Nr. 572

B	0	0	0	0	0	0	0	0	0	0	0	0	0	0	
A	80	5.8	6.9	8.7	10.7	11.2	12.7	14.8	17.4	19.2	22.9	24.6	25.7	28.4	34.4

Konen

Bauteil-Nr. 5

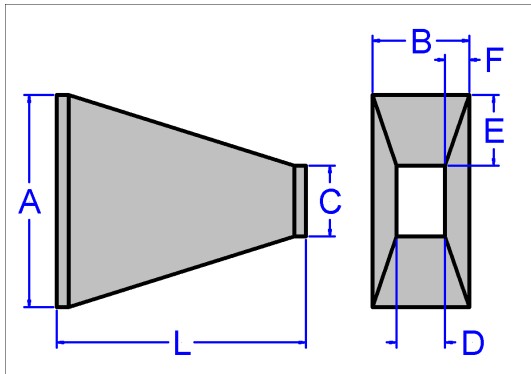

B		200	300	400	500	600	700	800	900	1000	1100	1200	1400	1600	1800	2000
A	200	42	50	54	56	71	79	99	106	129	136	149	198	211	216	227
	300	50	54	56	62	79	87	106	111	136	149	163	207	232	241	247
	400	54	56	62	67	87	92	111	118	149	163	172	212	246	255	261
	500	56	62	67	76	92	97	118	129	163	172	177	232	261	267	275
	600	71	79	87	92	97	102	129	142	172	177	185	246	270	277	283
	700	79	87	92	97	102	112	142	150	177	185	201	261	280	286	292
	800	99	106	111	118	129	142	149	155	185	201	215	271	297	305	313
	900	106	111	118	129	142	150	155	162	201	215	227	280	312	321	332
	1000	129	136	149	163	172	177	185	201	215	227	235	297	325	333	342
	1100	136	149	163	172	177	185	201	215	227	235	243	312	338	347	357
	1200	149	163	172	177	185	201	215	227	235	243	258	325	350	358	368
	1400	198	207	212	232	246	261	271	280	297	312	325	350	376	383	399
	1600	211	232	246	261	270	280	297	312	325	338	350	376	398	408	421
	1800	216	241	255	267	277	286	305	321	333	347	358	408	421	434	452
	2000	227	247	261	275	283	292	313	332	342	357	368	421	446	463	481

Mera-Tech GmbH
Wibachstrasse 8 CH-8153 Rümlang

Telefon: +41 44 817 20 12
Telefax: +41 44 817 20 11
Mobil: +41 79 104 12 20

Mail: r.saliji@mera-tech.ch



S-Etagen

Bauteil-Nr. 850

B
A

Bogen

Bauteil-Nr. 7

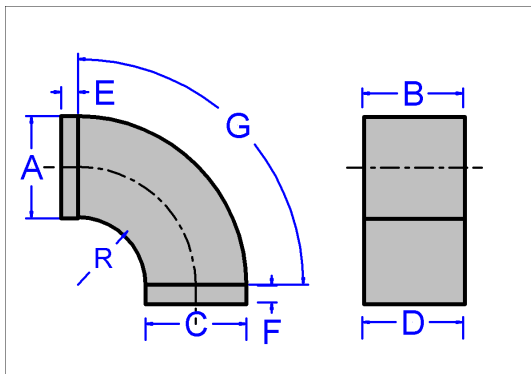

		B															
		200	300	400	500	600	700	800	900	1000	1100	1200	1400	1600	1800	2000	
A																	
200	35	38	42	46	52	60	73	77	89	94	97	111	121	125	130		
300	40	44	49	52	59	66	79	85	97	102	106	124	132	136	145		
400	45	50	55	59	66	73	86	92	106	111	115	136	145	155	169		
500	54	56	61	66	75	79	95	99	107	120	125	147	159	172	186		
600	66	70	75	77	84	87	104	107	124	130	136	160	174	186	200		
700	73	79	84	86	90	96	112	118	136	141	149	175	191	205	217		
800	97	102	106	110	115	118	122	127	146	153	160	192	207	223	240		
900	110	111	115	120	124	127	132	139	159	166	174	208	229	237	252		
1000	124	129	134	140	146	151	159	165	174	180	188	233	250	262	278		
1100	136	140	146	151	159	165	174	180	188	195	206	251	272	287	303		
1200	147	151	159	165	174	180	188	195	205	212	221	275	298	308	322		
1400	233	240	243	247	252	260	263	271	277	283	288	302	316	328	342		
1600	247	252	258	262	268	275	277	287	292	298	305	321	336	350	363		
1800	262	267	272	280	286	290	297	301	311	318	325	340	356	367	383		
2000	280	285	290	297	301	308	316	323	330	338	346	362	377	395	412		

Eckbogen

Bauteil-Nr. 8

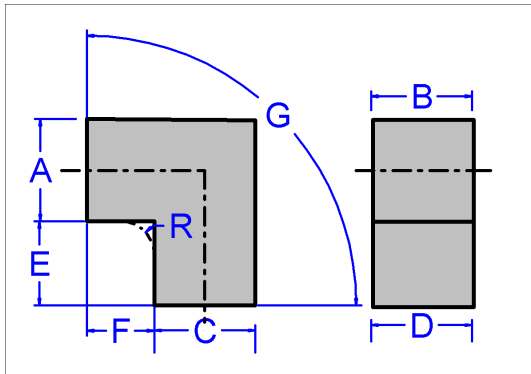

		B															
		200	300	400	500	600	700	800	900	1000	1100	1200	1400	1600	1800	2000	
A																	
200	55	61	67	70	84	97	116	124	142	149	157	177	194	206	219		
300	62	70	77	84	94	106	129	136	155	162	167	197	215	227	241		
400	73	79	87	94	104	115	139	146	167	175	185	216	232	250	266		
500	86	92	97	104	116	127	151	160	181	191	200	235	253	271	287		
600	105	111	120	125	132	139	163	172	198	207	216	258	277	296	313		
700	116	124	131	139	146	153	180	186	215	225	235	281	305	322	337		
800	156	162	167	174	181	188	195	205	235	245	257	306	336	348	366		
900	171	175	182	190	198	205	215	220	252	263	277	325	366	386	402		
1000	198	206	215	225	233	243	253	263	277	287	302	367	398	418	432		
1100	216	223	232	243	255	263	276	287	298	313	327	402	437	459	479		
1200	235	243	253	262	276	287	301	312	325	340	354	436	477	498	518		
1400	371	379	389	397	403	414	424	434	443	453	462	481	506	524	542		
1600	393	403	412	421	432	438	449	466	471	479	492	513	537	554	576		
1800	420	431	436	446	454	466	476	488	498	508	521	544	568	594	612		
2000	444	452	466	473	481	494	504	522	529	539	553	577	605	625	642		

Mera-Tech GmbH
Wibachstrasse 8 CH-8153 Rümlang

Telefon: +41 44 817 20 12
Telefax: +41 44 817 20 11
Mobil: +41 79 104 12 20

Mail: r.saliji@mera-tech.ch



Uebergang

Bauteil-Nr.

B
A

T-Stücke

Bauteil-Nr. 10

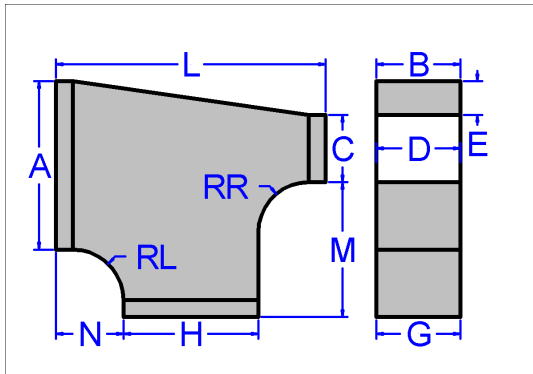

B	200	300	400	500	600	700	800	900	1000	1100	1200	1400	1600	1800	2000
A	200	300	400	500	600	700	800	900	1000	1100	1200	1400	1600	1800	2000
200	62	67	71	79	94	97	120	124	156	162	166	202	212	217	225
300	73	77	81	87	102	107	130	134	169	175	180	216	227	233	246
400	79	85	90	97	112	118	140	147	182	188	195	232	246	255	276
500	87	95	101	107	122	130	153	159	198	207	210	251	263	271	287
600	111	116	124	130	136	142	166	172	216	220	226	271	285	293	313
700	124	130	136	142	150	157	181	188	231	237	246	292	305	315	327
800	147	153	162	169	180	188	197	207	247	258	263	313	332	350	366
900	162	167	176	184	194	205	215	225	270	278	286	336	356	366	382
1000	226	237	245	252	258	267	271	283	292	298	308	363	391	397	407
1100	250	257	263	272	280	290	297	307	315	323	332	392	420	427	437
1200	270	277	286	295	302	312	322	331	340	351	358	428	451	459	471
1400	318	327	336	347	356	371	379	392	402	417	433	459	488	496	513
1600	342	351	363	372	388	398	409	424	437	453	473	498	528	541	567
1800	368	381	392	407	423	433	446	461	476	498	504	539	574	588	614
2000	399	412	426	441	453	468	481	498	514	531	547	584	619	635	657

Boden

Bauteil-Nr. 38

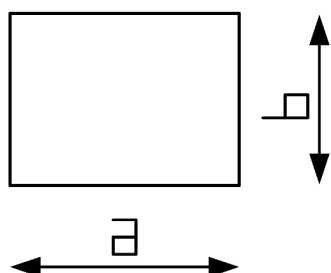

	200	300	400	500	600	700	800	900	1000	1100	1200	1400	1600	1800	2000	
B																
A	200	14	14	14	14	15	16	16	23	23	24	25	26	34	36	49
300	14	14	15	16	17	18	19	26	27	28	29	31	40	42	56	
400	14	15	16	17	19	20	21	29	30	32	33	36	46	48	63	
500	14	16	17	19	20	22	23	32	34	36	37	41	51	55	70	
600	15	17	19	20	22	24	26	35	37	39	41	46	57	61	77	
700	16	18	20	22	24	26	28	38	41	43	46	51	62	67	84	
800	16	19	21	23	26	28	30	41	44	47	50	56	68	74	91	
900	23	26	29	32	35	38	41	45	48	51	54	60	74	80	98	
1000	23	27	30	34	37	41	44	48	51	55	58	65	79	86	105	
1100	24	28	32	36	39	43	47	51	55	59	63	70	85	93	112	
1200	25	29	33	37	41	46	50	54	58	63	67	75	91	99	119	
1400	26	31	36	41	46	51	56	60	65	70	75	85	102	112	133	
1600	34	40	46	51	57	62	68	74	79	85	91	102	113	124	147	
1800	38	44	51	57	64	71	77	84	91	97	104	117	131	144	169	
2000	49	56	63	70	77	84	91	98	105	112	119	133	147	161	175	

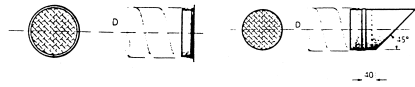

547	548	648
S MG	S MG45	S SMG45
Maschengitter	Maschengitter 45°	Maschengitter 45° Safe

100	29.00	28.80	29.40
125	32.00	31.30	30.10
150	35.00	35.10	33.80
175	38.00	35.10	36.70
200	42.00	37.10	38.00
225	45.00	41.00	40.00
250	49.00	43.80	44.60
275	51.00	46.40	46.40
300	55.00	48.80	49.80
325	60.00	52.80	53.20
350	62.00	53.80	
400	75.00	57.60	
450	80.00	60.60	
500	87.00	67.80	
550	95.00	75.20	
600	102.00	80.30	

Mera-Tech GmbH
Wibachstrasse 8 CH-8153 Rümlang

Telefon: +41 44 817 20 12
Telefax: +41 44 817 20 11
Mobil: +41 79 104 12 20

Mail: r.saliji@mera-tech.ch



Flexmanschette

Bauteil-Nr.

B
A

Mera-Tech GmbH
Wibachstrasse 8 CH-8153 Rümlang

Telefon: +41 44 817 20 12
Telefax: +41 44 817 20 11
Mobil: +41 79 104 12 20

Mail: r.saliji@mera-tech.ch



2 KOMPONENTEN

Einstellklappen	2.010
Motorklappen ALU	2.020
Wetterschutzgitter ALU	2.030
Regenhüte rund	2.040
Regenhüte eckig	2.050
Schalldämpfer-Kulissen 100 mm	2.061
Schalldämpfer-Kulissen 100 mm Spezifikationen	2.062
Schalldämpfer-Kulissen 150 mm	2.063
Schalldämpfer-Kulissen 150 mm Spezifikationen	2.064
Schalldämpfer-Kulissen 200 mm	2.065
Schalldämpfer-Kulissen 200 mm Spezifikationen	2.070



Einstellklappen

Bauteil-Nr. 22

B	200	300	400	500	600	700	800	900	1000	1100	1200	1400	1600	1800	2000
A															
200	75	87	99	118	131	153	176	197	216	236	266	327	358	408	454
300	80	94	106	124	146	175	194	211	235	267	321	353	403	451	488
400	89	96	111	129	157	185	201	221	260	301	333	371	431	478	516
500	96	105	124	150	171	198	211	233	272	315	348	399	452	506	544
600	102	110	134	163	190	207	221	243	286	330	371	420	478	533	576
700	106	114	147	171	201	219	233	255	296	350	386	443	499	559	609
800	112	118	160	181	208	227	242	270	305	363	403	466	527	583	643
900	118	127	171	191	217	242	255	286	323	386	421	484	549	614	713
1000	130	174	217	243	275	305	340	372	401	446	522	618	650	689	794
1100	174	191	227	266	318	350	371	426	471	554	594	677	763	834	905
1200	191	208	246	276	323	362	406	446	486	589	624	732	789	868	940
1400	211	231	276	303	363	411	458	357	603	621	667	773	853	931	1041
1600	233	257	303	332	402	449	502	557	611	644	693	794	878	986	1070
1800	257	297	332	409	432	494	557	619	680	715	759	835	914	1014	1161
2000	278	318	388	417	476	532	593	675	710	763	818	924	1022	1106	1226

Motorklappen ALU

Bauteil-Nr. 21

B	200	300	400	500	600	700	800	900	1000	1100	1200	1400	1600	1800	2000
A															
200	67	79	90	107	118	140	162	180	190	217	242	295	323	363	401
300	73	85	96	112	132	162	176	192	215	245	292	321	367	409	443
400	81	87	101	116	142	169	182	201	236	272	303	336	388	434	469
500	87	95	112	136	155	181	192	211	247	286	316	363	411	459	494
600	92	99	122	147	172	188	201	221	260	298	336	382	434	486	373
700	96	104	134	155	182	198	211	232	268	318	351	402	454	508	554
800	102	107	145	165	190	207	220	245	277	330	367	423	478	531	584
900	106	115	155	174	197	220	232	260	295	351	383	441	499	558	649
1000	118	157	198	221	250	277	308	338	365	406	473	563	590	627	722
1100	157	175	207	240	288	318	350	386	428	504	541	615	693	758	824
1200	174	190	225	251	295	328	368	406	442	534	567	664	718	789	854
1400	192	210	250	276	330	373	416	458	548	563	605	703	775	846	946
1600	211	232	276	302	366	408	457	506	554	586	629	722	798	896	972
1800	233	271	302	372	392	449	506	563	618	650	690	759	831	921	1055
2000	253	288	353	379	432	484	539	614	645	693	744	840	927	1006	1115



Wetterschutzgitter ALU

Bauteil-Nr. 24

B	200	300	400	500	600	700	800	900	1000	1100	1200	1400	1600	1800	2000
A															
200	45	50	55	62	71	81	90	96	106	120	137	175	197	212	240
300	49	54	59	66	76	86	94	104	118	134	151	197	212	233	257
400	51	56	62	70	81	92	99	110	127	147	165	217	233	257	281
500	54	60	66	76	86	96	105	120	137	169	180	240	257	281	307
600	56	64	69	81	92	104	112	136	157	184	197	260	293	303	333
700	61	67	73	86	96	110	122	150	172	201	217	290	301	330	360
800	64	70	80	94	104	118	136	165	192	216	237	316	327	367	423
900	67	90	99	122	134	151	171	195	227	233	258	341	363	389	458
1000	71	95	105	131	142	160	180	212	245	255	281	371	388	411	496
1100	75	96	107	134	147	163	186	219	255	277	293	381	426	472	513
1200	77	97	110	137	150	166	192	225	266	292	313	395	412	492	533
1400	94	102	114	142	157	174	206	237	288	328	354	420	488	538	576
1600	101	112	125	157	169	188	226	263	327	348	389	472	521	567	635
1800	120	136	149	165	192	215	236	277	344	366	432	506	537	611	694
2000	140	145	156	172	202	226	252	295	365	426	471	551	614	654	784

Regenhüte rund

27

RHR

Regenhut rund

100		150.00
125		190.00
150		215.00
175		229.00
200		271.00
250		328.00
300		351.00
350		371.00
400		446.00
450		502.00
500		567.00
550		653.00
600		724.00
650		785.00
700		888.00
750		984.00
800		1107.00
850		1170.00
900		1245.00
950		1329.00
1000		1567.00

Regenhüte eckig

Bauteil-Nr. 100

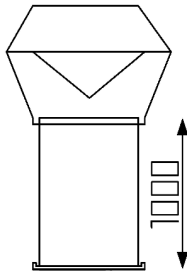

	B															
	200	300	400	500	600	700	800	900	1000	1100	1200	1400	1600	1800	2000	
A	200	508	545	581	618	655	692	729	766	802	839	876	950	1023	1097	1198
300	545	581	618	655	692	729	766	802	839	876	913	986	1060	1147	1248	
400	581	618	655	692	729	766	802	839	876	913	950	1023	1097	1198	1299	
500	618	655	692	729	766	802	839	876	913	950	986	1060	1147	1248	1349	
600	655	692	729	766	802	839	876	913	950	986	1023	1097	1198	1299	1400	
700	692	729	766	802	839	876	913	950	986	1023	1060	1147	1248	1349	1450	
800	729	766	802	839	876	913	950	986	1023	1060	1097	1198	1299	1400	1501	
900	766	802	839	876	913	950	986	1023	1060	1097	1147	1248	1349	1450	1551	
1000	802	839	876	913	950	986	1023	1060	1097	1147	1198	1299	1400	1501	1602	
1100	839	876	913	950	986	1023	1060	1097	1147	1198	1248	1349	1450	1551	1666	
1200	876	913	950	986	1023	1060	1097	1147	1198	1248	1299	1400	1501	1602	1730	
1400	950	986	1023	1060	1097	1147	1198	1248	1299	1349	1400	1501	1602	1730	1858	
1600	1023	1060	1097	1147	1198	1248	1299	1349	1400	1450	1501	1602	1730	1858	1986	
1800	1097	1147	1198	1248	1299	1349	1400	1450	1501	1551	1602	1730	1858	1986	2115	
2000	1198	1248	1299	1349	1400	1450	1501	1551	1602	1666	1730	1858	1986	2115	2243	

Schalldämpfer-Kulissen 100 mm

Bauteil-Nr. 52

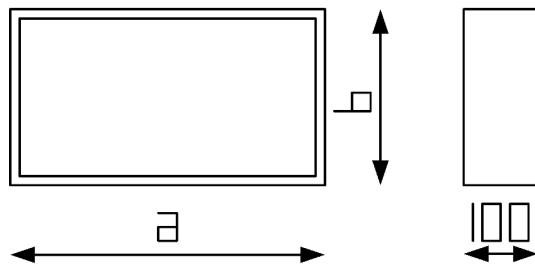

B		200	300	400	500	600	700	800	900	1000	1100	1200	1300	1400	1500	1600	1700	1800	1900	2000
A	500	49	51	54	55	59	60	62	66	69	71	76	79	81	85	87	90	92	95	97
	750	51	55	59	64	66	70	73	77	81	85	87	92	96	101	106	112	120	124	132
	1000	60	64	67	70	76	84	90	97	105	107	111	114	116	118	124	129	132	137	142
	1250	67	70	75	77	84	90	97	106	114	125	137	147	159	172	177	184	191	197	201
	1500	76	77	80	84	90	97	104	111	118	132	149	165	180	195	202	211	220	229	236
	1750	79	84	86	90	97	111	116	122	130	147	166	182	200	216	225	233	241	247	257
	2000	86	90	94	97	106	116	125	132	141	160	180	198	219	237	246	255	263	275	281

Dämpfungs- und Druckverlustkurve

Kulissenstärke 100 mm
 Länge 1000 mm

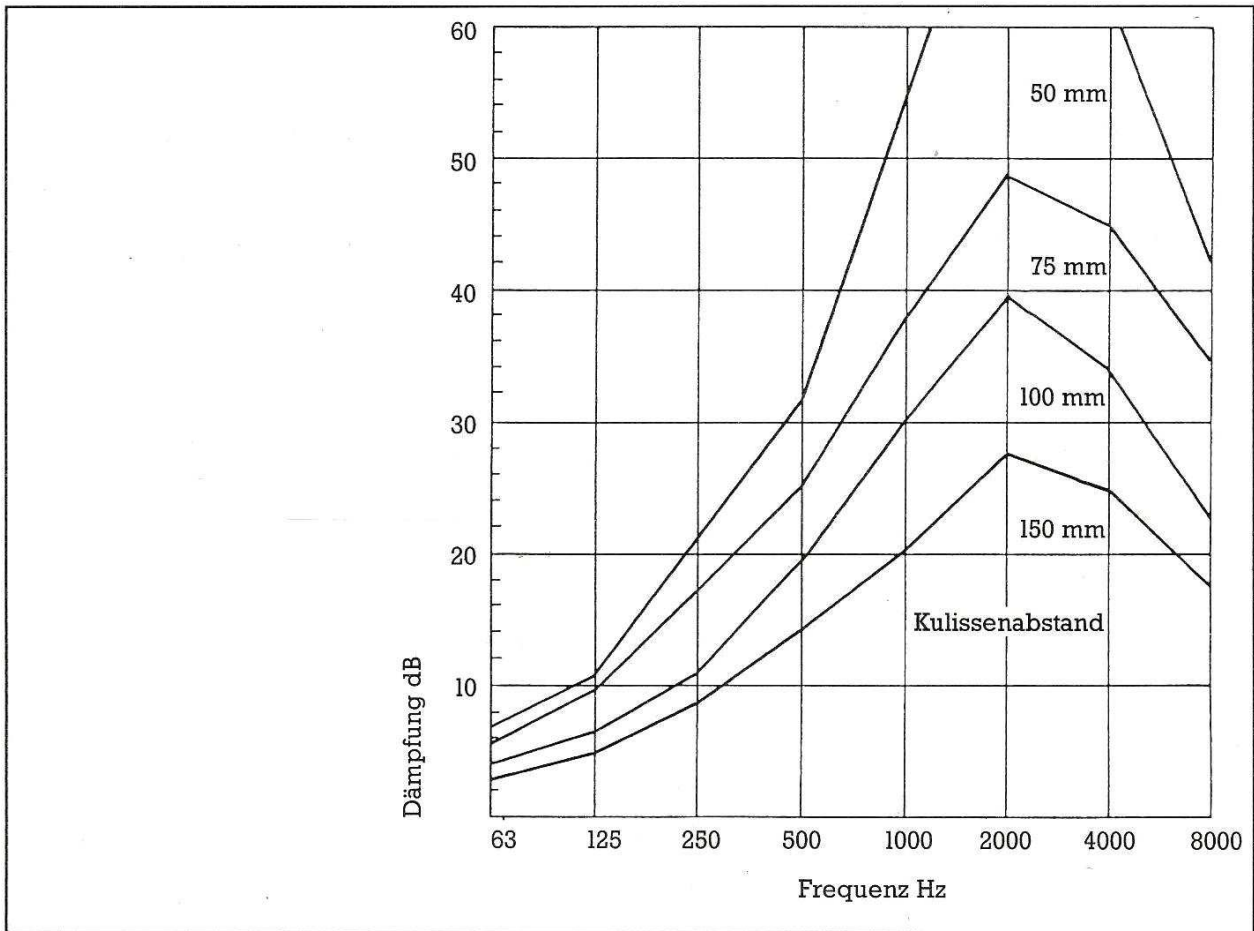
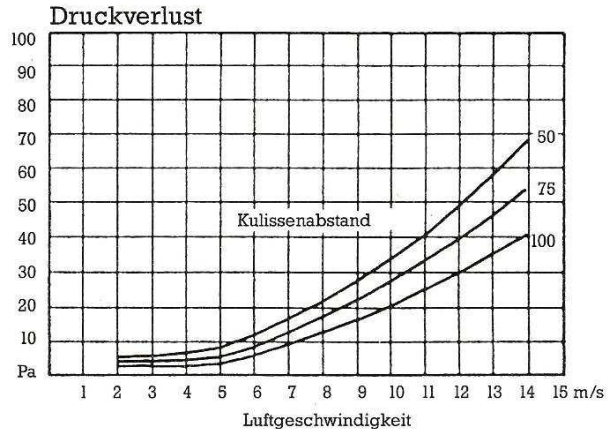

Schalldämpfer-Kulissen 150 mm

Bauteil-Nr. 53

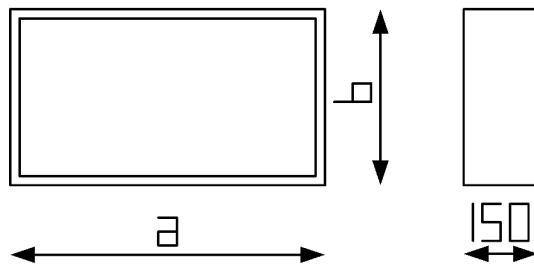

B		200	300	400	500	600	700	800	900	1000	1100	1200	1300	1400	1500	1600	1700	1800	1900	2000
A	500	50	52	56	61	64	67	70	76	79	81	85	87	92	96	99	102	105	110	114
	750	56	60	66	70	76	80	85	90	94	99	105	110	114	120	124	130	134	139	142
	1000	62	67	71	79	85	90	97	104	110	115	121	127	134	140	146	153	159	165	171
	1250	70	76	80	86	94	101	110	118	132	141	157	172	188	202	211	221	229	237	247
	1500	77	84	87	96	105	114	124	132	140	156	174	191	207	223	235	245	257	267	278
	1750	85	89	94	106	115	125	134	145	155	172	190	208	229	245	255	267	278	288	305
	2000	92	97	102	114	125	137	147	159	172	192	215	235	255	277	287	297	308	321	331

Dämpfungs- und Druckverlustkurve

Kulissenstärke 150 mm
 Länge 1000 mm

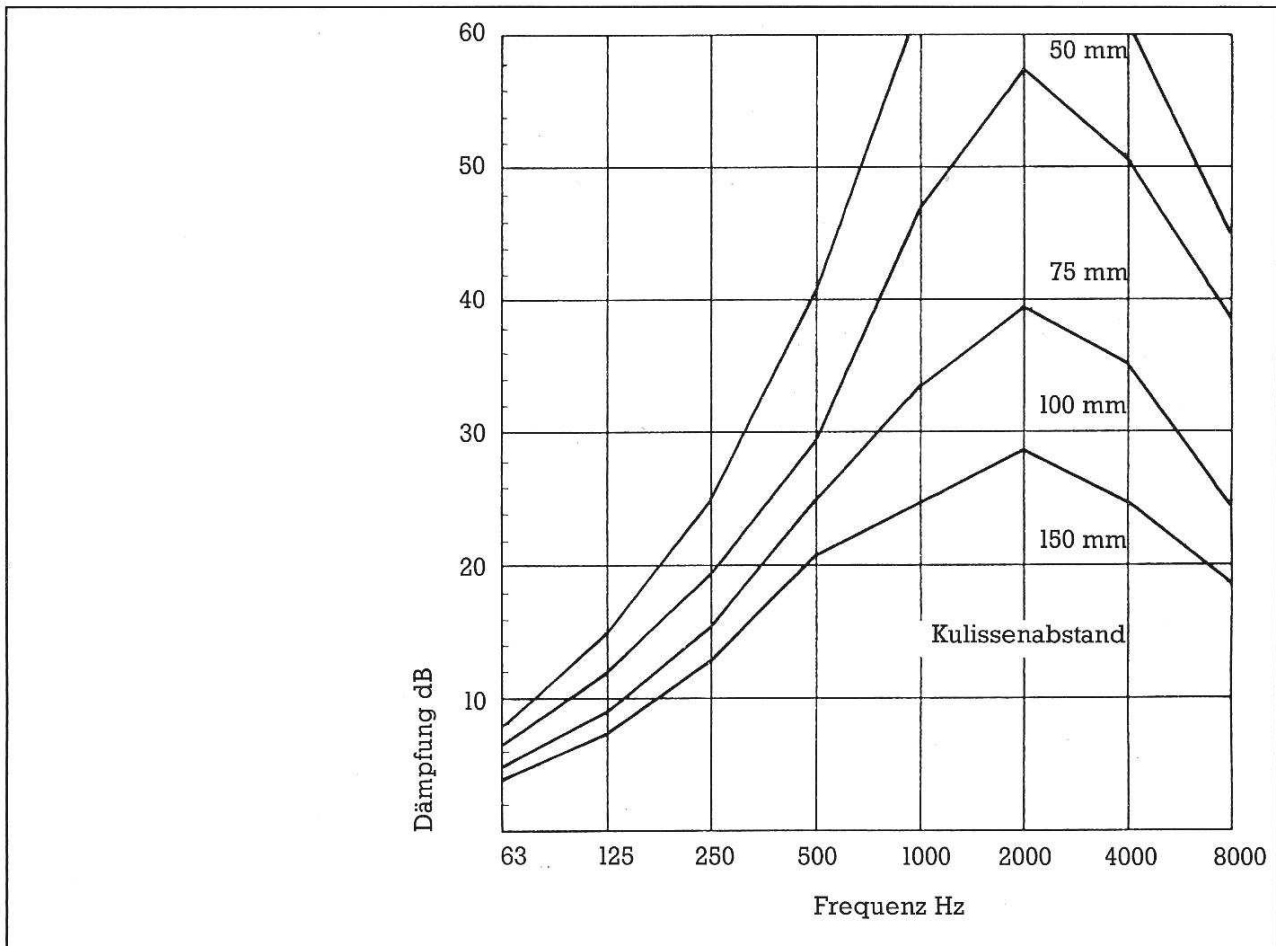
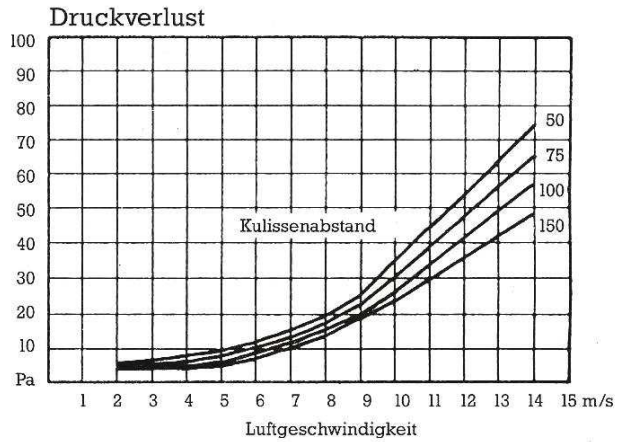

Schalldämpfer-Kulissen 200 mm

Bauteil-Nr. 54

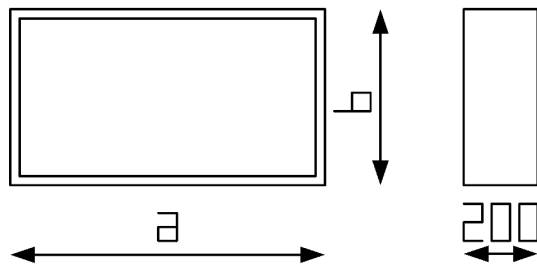

B		200	300	400	500	600	700	800	900	1000	1100	1200	1300	1400	1500	1600	1700	1800	1900	2000
A	500	54	56	60	64	69	73	77	81	85	89	94	97	102	107	111	115	120	122	125
	750	60	64	73	76	81	87	96	99	104	110	115	121	127	132	140	145	151	157	162
	1000	67	71	79	87	96	105	112	116	124	131	137	145	153	159	166	175	182	188	197
	1250	71	77	96	104	110	118	125	132	139	157	176	195	211	227	236	246	257	267	277
	1500	80	86	104	107	120	130	140	149	159	180	195	219	235	253	263	276	288	302	313
	1750	87	92	114	118	129	141	153	166	177	198	220	241	261	285	296	307	321	333	346
	2000	94	99	124	127	136	153	169	184	197	220	243	267	288	312	325	341	353	367	381

Dämpfungs- und Druckverlustkurve

Kulissenstärke 200 mm
Länge 1000 mm

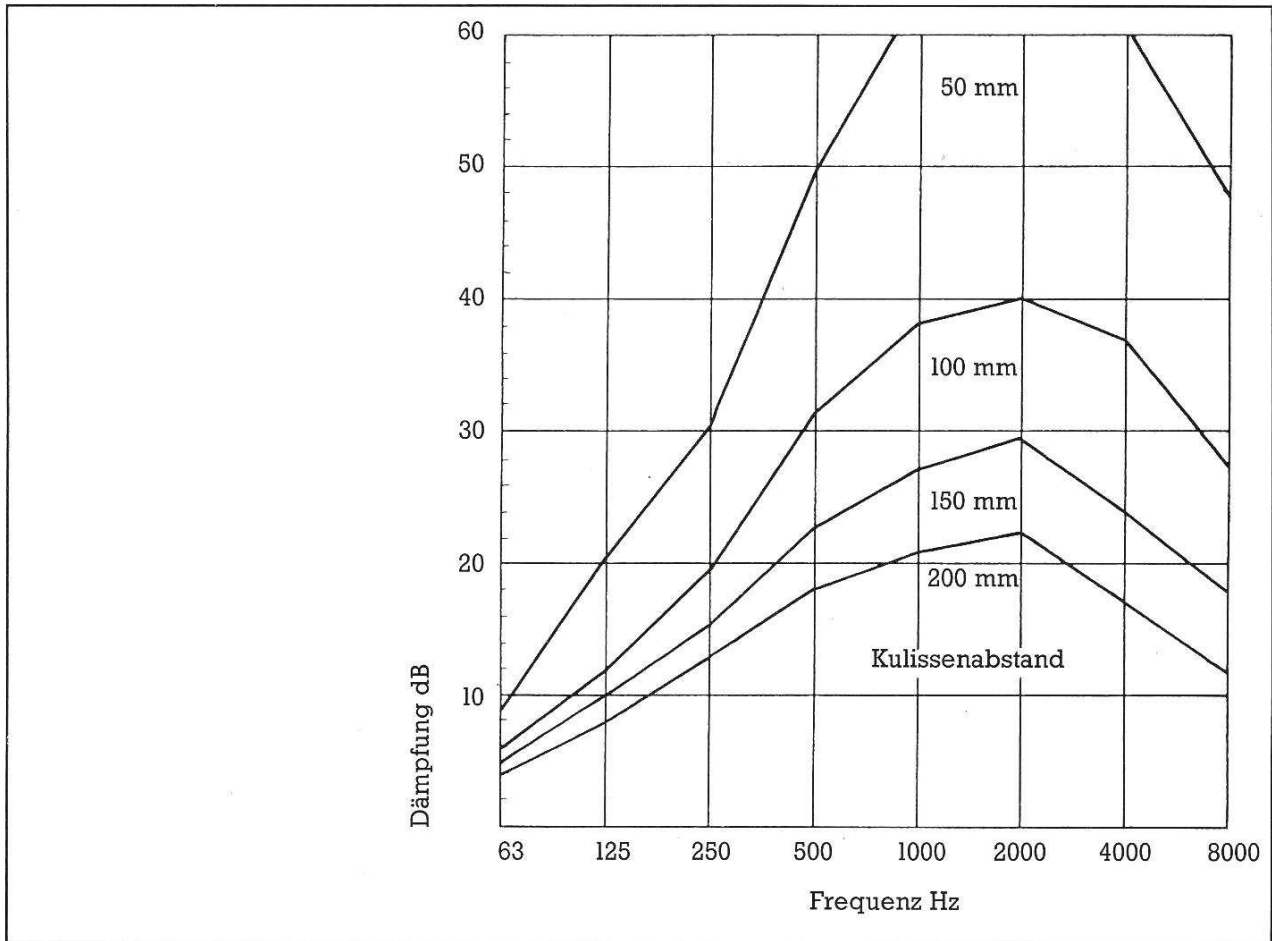
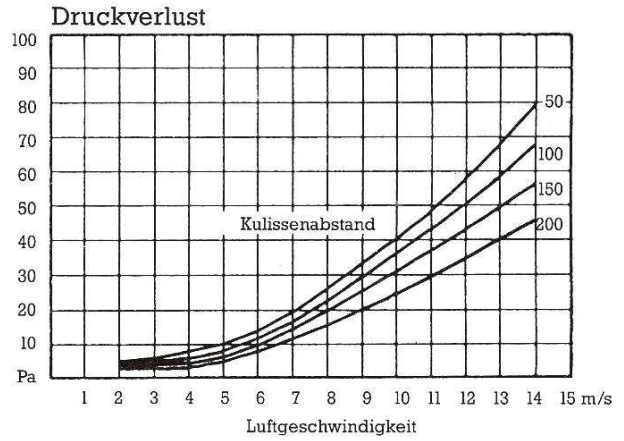

Mera-Tech GmbH
Wibachstrasse 8 CH-8153 Rümlang

Telefon: +41 44 817 20 12
Telefax: +41 44 817 20 11
Mobil: +41 79 104 12 20

Mail: r.saliji@mera-tech.ch



3 RUNDPROGRAMM

Verbindungen, Rohre	3.010
Rohrbogen	3.020
Segmentbogen	3.030
Reduktionen	3.040
T- und Sattelstücke, Hosenrohre	3.050
Maschengitter Stutzen Deckel	3.060
Rondellen und Einstellklappen	3.070
Schlauchbriden	3.080
Rohrbriden	3.090

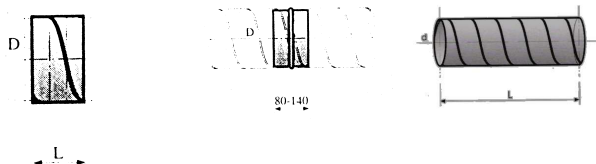

NW D	506	505	500
	S VBR Muffe Rohr/Verbindungsrohr	S MU Muffe/Nippel	S SR Spirorohr
80	3.00	5.70	4.50
100	3.60	6.20	5.37
125	4.40	6.20	7.00
150	4.70	7.00	8.34
160	4.80	7.00	9.17
180	4.90	8.30	10.50
200	5.00	9.00	11.67
224	5.20	9.50	13.00
250	6.30	10.50	14.34
280	6.30	12.50	15.34
300	6.30	14.00	16.34
315	7.00	14.00	18.34
355	8.00	17.00	20.67
400	12.60	21.00	23.34
450	12.60	25.00	26.00
500	19.00	29.00	34.97
560	19.50	37.00	50.13
600	20.50	39.00	52.04
630	28.00	41.00	60.00
710	25.50	69.00	63.34
800	32.50	75.00	73.34
900	35.00	87.00	83.34
1000	38.00	113.00	90.00

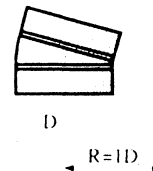
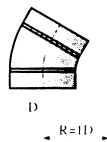
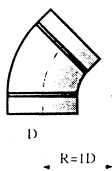
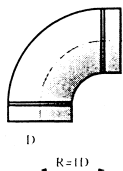

	507	508	509	510	
	S RB90	S RB45	S RB30	S RB15	
	Rohrbogen 90° safe	Rohrbogen 45° safe	Rohrbogen 30°	Rohrbogen 15°	

NW

D

80		13.00	11.00	10.00	13.00
100		13.00	11.00	11.00	14.00
125		14.00	13.00	12.00	15.00
150		21.00	16.00	16.00	17.00
160		23.00	17.00	17.00	18.00
180		29.00	20.00	19.00	21.00
200		31.00	21.00	21.00	23.00
224		47.00	33.00	47.00	28.00
250		50.00	36.00	36.00	32.40

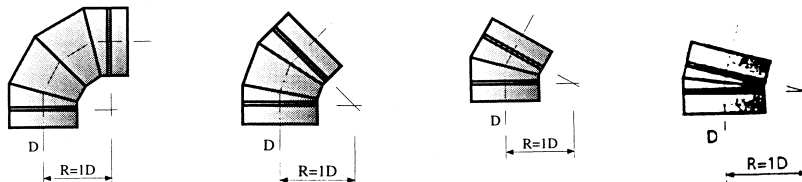

	511	512	513	514	
--	-----	-----	-----	-----	--

NW

	S SB90	S SB45	S SB30	S SB15
	Segmentbogen 90° safe	Segmentbogen 45° safe	Segmentbogen 30°	Segmentbogen 15°

D

		511	512	513	514
250		50.00	39.00	32.00	32.00
280		53.00	39.00	33.00	33.00
300		60.00	43.00	37.00	37.00
315		74.00	49.00	40.00	41.00
355		93.00	59.00	49.00	47.00
400		93.00	77.00	64.00	57.00
450		115.00	88.00	75.00	73.00
500		130.00	100.00	77.00	77.00
560		170.00	122.00	100.00	85.00
600		240.00	149.00	131.00	110.00
630		260.00	158.00	126.00	126.00
710		430.00	280.00	240.00	185.00
800		560.00	275.00	245.00	190.00
900		670.00	400.00	340.00	255.00
1000		780.00	440.00	355.00	348.00

Mera-Tech GmbH

Wibachstrasse 8 CH-8153 Rümlang

Telefon: +41 44 817 20 12

Telefax: +41 44 817 20 11

Mobil: +41 79 104 12 20

Mail: r.saliji@mera-tech.ch



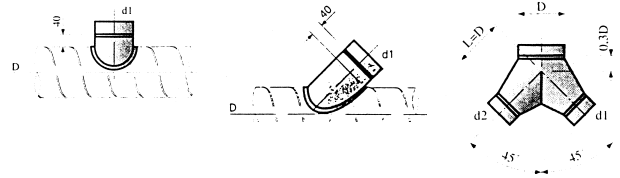

		535	538	530
--	--	-----	-----	-----

NW
 D

S SS	S SS45	S GS
Sattelstück	Sattelstück 45°	Gabelstück 2x45°

5.10	23.00	61.80
5.60	23.00	64.30
6.40	25.00	66.80
16.30	28.00	71.90
8.10	26.50	70.50
8.10	27.00	70.50
9.80	28.20	75.40
11.20	31.50	82.20
16.80	33.70	88.90
18.00	36.20	96.40
31.50	41.00	102.40
33.40	43.00	111.20
34.20	45.00	113.70
38.30	48.50	123.60
46.90	52.50	151.60
52.80	56.20	182.00
58.20	67.20	225.90

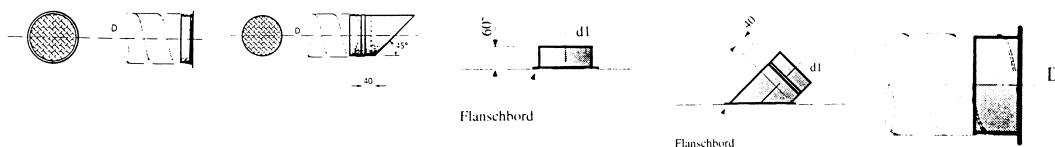

NW	547		548		541		543		545	
	S MG Maschengitter		S MG45 Maschengitter 45°		S STU Stutzen E.B.		S STU45 Stutzen 45°		S DE Deckel	
D										
100		29.00		28.80		5.00		34.00		7.60
125		32.00		31.30		5.40		38.00		7.60
150		35.00		35.10		5.60		41.00		7.90
175		38.00		35.10		6.10		45.00		8.90
200		42.00		37.10		6.30		50.00		8.90
225		45.00		41.00		10.00		54.00		12.20
250		49.00		43.80		8.20		59.00		12.90
275		51.00		46.40		9.20		62.00		17.70
300		55.00		48.80		9.70		67.00		17.70
325		60.00		52.80		12.50		71.00		21.30
350		62.00		53.80		12.80		75.00		22.10
400		75.00		57.60		12.80		80.00		22.50
450		80.00		60.60		14.40		87.00		30.40
500		87.00		67.80		19.00		96.00		31.50
550		95.00		75.20		21.80		110.00		48.40
600		102.00		80.30		23.50		118.00		48.90
						30.30				59.20
						32.90				59.80
						34.00				61.10
						43.40				146.00
						53.60				153.30
						59.20				188.60
						87.20				191.60

Mera-Tech GmbH

Wibachstrasse 8 CH-8153 Rümlang

Telefon: +41 44 817 20 12

Telefax: +41 44 817 20 11

Mobil: +41 79 104 12 20

Mail: r.saliji@mera-tech.ch



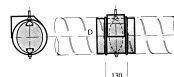
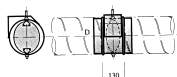

	549	552	873
	S EK	S MEK	
NW	Einstellklappe	Motor- Einstellklappe	WLVGRKHR160/6/9 0
D			
80	23.10	58.80	
100	28.00	62.20	
125	29.20	63.30	
140	30.30	63.80	
150	30.30	64.30	
160	30.90	64.50	
180	31.50	64.90	
200	32.00	65.50	
224	32.60	68.00	
250	37.10	71.70	
280	41.60	76.60	
300	49.50	85.30	
315	50.50	86.20	
355	56.20	92.10	
400	82.00	124.10	
450	87.70	162.60	
500	134.80	181.10	

Schlauchbriden

571

Bri

Schlauchbriden

90		1.60
110		1.60
135		1.90
165		2.10
215		2.80
270		3.30
325		3.60
370		4.20
525		5.80
660		6.40

Mera-Tech GmbH

Wibachstrasse 8 CH-8153 Rümlang

Telefon: +41 44 817 20 12

Telefax: +41 44 817 20 11

Mobil: +41 79 104 12 20

Mail: r.saliji@mera-tech.ch



580	553
rohrsm8	S SK
Rohrbriden klein (M8)	Schalungsknie

80	4.30	32.00
100	4.50	31.50
125	5.10	32.40
140	5.50	35.00
150	5.60	35.00
160	5.80	35.90
180	6.20	41.90
200	6.70	47.25
225	7.20	
250	7.90	
280	8.30	
300	9.00	
315	9.30	
355	9.50	
400	10.70	